



乐清市裕林电子有限公司

Yueqing Yulin Electrical Co., Ltd

Address: F/6 No.19 Keaisi road xiangyang industrial zone road tantou liushi yueqing wenzhou

Tel: 0577-27878383

website: www.indicatorlight.com

Fax: 0577-27878383-8027

SPECIFICATION FOR APPROVAL

规格说明书

CUSTOMER'S CODE

本厂代码:

DESCRIPTION

品名:

FLM30-11FEJ 平头环形插脚金属按钮

SPECIFICATION

规格:

30mm

DATE

编制日期:

PART NO.

本厂型号:

REFERENCE No.

档案编号:

| Approved By Customer 编制 | Qualified By 审核 | Form Designer 批准 |
|----------------------------|--------------------|---------------------|
| | | |



乐清市裕林电子有限公司

Yueqing Yulin Electrical Co., Ltd

Address: F/6 No.19 Keaisi road xiangyang industrial zone road tantou liushi yueqing wenzhou

Tel: 0577-27878383

website: www.indicatorlight.com

Fax: 0577-27878383-8027

1. 图片 Picture:



2. 图纸 drawing

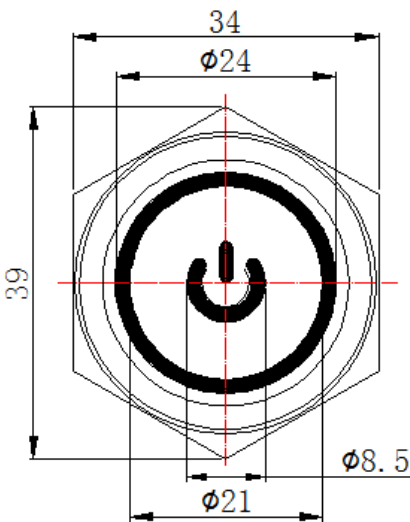

电气简图

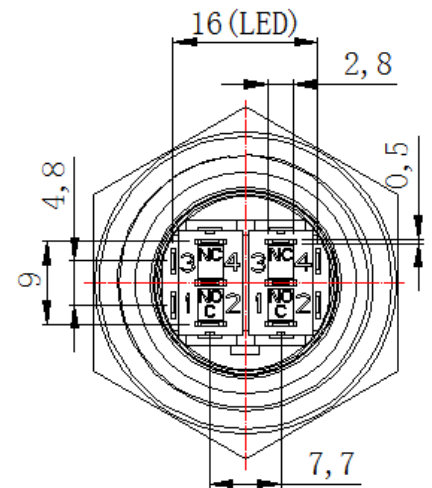
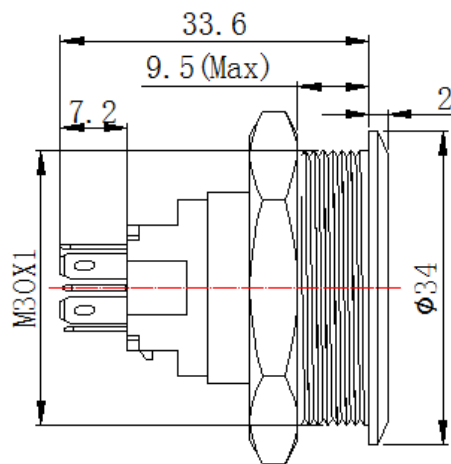

安装孔图

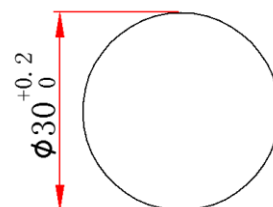
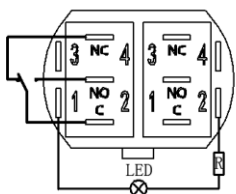

3 配件材料 component material

| 配件名 Component name | 材料 material |
|-----------------------|---|
| 导光按键 | PC 塑料 PC plastic |
| 按键 | 304 不锈钢 304Stainless steel |
| 外壳套筒 | H59黄铜/304不锈钢 H59 nickel plated brass/304Stainless steel |
| 按钮引脚 | H62 铜合金 |
| 防水圈 rubber ring | SIL 硅胶 SIL silica gel |
| 螺帽 nut | H59 黄铜 H59 nickel plated brass |
| 底座 housing | PA66+GF20%阻燃尼龙 PA66+GF20% nylon |
| 光源 Light source | LED LED 灯 |
| 电阻 Resistor | 金属膜电阻 Metal film |

4 性能参数 performance parameter

| 项目 items | 参数 parameter |
|--|-----------------------------------|
| 开关额定电压 Rated voltage | 36V DC 250V AC |
| 开关额定电流 rated current | 5A DC 5A AC |
| 指示灯额定电压 | 3V-220V |
| 指示灯额定电流 | ≤20mA |
| 额定功率 rated power | 180W (DC) 1250W (AC) |
| 绝缘耐压 Insulation and voltage resistance | 1800V |
| 接触电阻: Point resistanc: | ≤50mΩ |
| 绝缘电阻: Isolation resistance: | ≥1000MΩ |
| 机械寿命 | 50 万次 |
| 电气寿命 electrical life | 10 万次 (250V/3A) 5 万次 (250V/5A) |
| 工作环境温度 Operating temperature | -25℃~+85℃ |
| 防护等级(头部) IP degree | IP67 IK09 |
| 指示灯颜色 | 红蓝绿黄白色 |



乐清市裕林电子有限公司

Yueqing Yulin Electrical Co., Ltd

Address: F/6 No.19 Keaisi road xiangyang industrial zone road tantou liushi yueqing wenzhou

Tel: 0577-27878383

website: www.indicatorlight.com

Fax: 0577-27878383-8027

4. Detailed Picture :



5.LED Specification:

■ Emitter 外型图

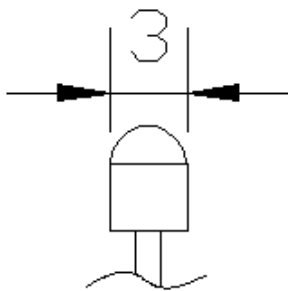

Spatial Distribution

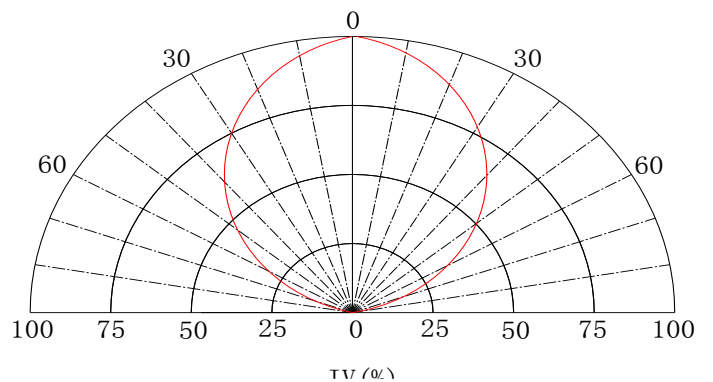



乐清市裕林电子有限公司

Yueqing Yulin Electrical Co., Ltd

Address: F/6 No.19 Keaisi road xiangyang industrial zone road tantou liushi yueqing wenzhou

Tel: 0577-27878383

website: www.indicatorlight.com

Fax: 0577-27878383-8027

■ Absolute Maximum Rating 极限工作参数

| 参数 Parameter | 符号 Symbol | 单位 Unit | 极限参数 Maximum Rating |
|---------------------------------------|----------------|------------|------------------------|
| 耗散功率 Power Dissipation | P | MW | 60 |
| 连续正向电流 Continuous Forward Current | I _F | MA | 25 |
| 反向电压 Reverse Voltage | V _R | V | 5 |
| 工作温度范围 Operating Temperature Range | Top | °C | -25 to +80 |
| 存放温度范围 Storage Temperature Range | Tst | °C | -25 to +90 |
| 最高焊接温度 Soldering Temperature | Tso | °C | 260 (for 5 second) |

*Ifp Conditions: Pulse Wide ≤ 10msec ≤ 1/10

瞬间脉冲电流

*Tsol Conditions: 3mm from the base of epoxy bulb 最高焊接温度 距胶体 3mm

Typical electrical-optical Characteristics curvers

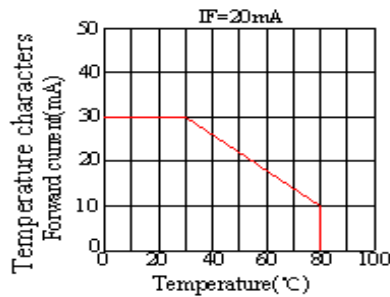
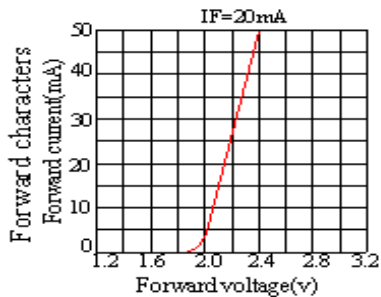

Notes:

The data are an typical presentation of the product, Contact customer service for details of technical information and warranty.

The product is sensitive to static antistatic operation environment is recommended

Products are shipped in either bulk bag package or taping.

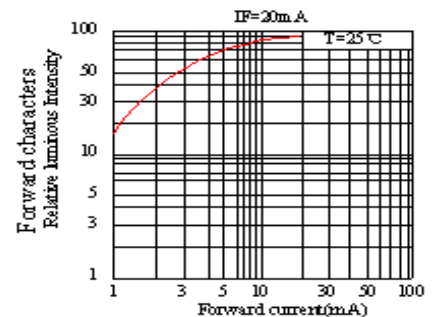
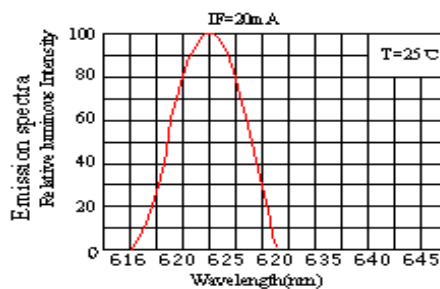
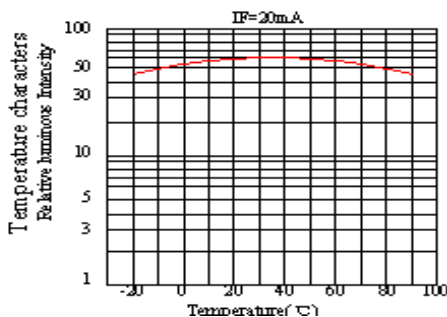



乐清市裕林电子有限公司

Yueqing Yulin Electrical Co., Ltd

Address: F/6 No.19 Keaisi road xiangyang industrial zone road tantou liushi yueqing wenzhou

Tel: 0577-27878383

website: www.indicatorlight.com

Fax: 0577-27878383-8027

Typical Optical/Electrical Characteristics 光电特性参数

| | | | |
|-------------------------------------|--------------|-----------------------------|------------------------|
| Color parameters 色参数 | | Optical Brightness 光亮度 | 0.00 cd/m ² |
| Main Wavelength 主波长 | 520.7.0 nm | light intensity 光强度 | 1000 mcd |
| Peak Wavelength 峰值波长 | 632.2 nm | luminous flux 光通量 | 4.8 lm |
| Peak width 峰值带宽 | 21.3 nm | luminous power 光功率 | 0.32 mW |
| colour coordinates xy 色坐标 xy | (.1404.7126) | luminous efficacy 发光效率 | 56.81 lm/W |
| colour coordinates u'v' 色坐标 u'v' | (.0498.5690) | forward current 正向电流 | 20.00 mA |
| colour purity 色纯度 | 0.758 | alternating voltage 交流电压 | 4.22 V |
| Color temperature 色温 | 8400k | AC power 交流电功率 | 0.084 W |

Notes:

1. Work absolute ratings Ta=25°C humidity=60% 工作常规值 温度=25°C 湿度=60%
2. Tolerance of measurement of forward voltage±0.1V 正向电压误差范围±0.1V
3. Test Machine: SSP6612 series LED test system



乐清市裕林电子有限公司

Yueqing Yulin Electrical Co., Ltd

Address: F/6 No.19 Keaisi road xiangyang industrial zone road tantou liushi yueqing wenzhou

Tel: 0577-27878383

website: www.indicatorlight.com

Fax: 0577-27878383-8027

LED LAMP RELIABILITY

| Type | Test Item | REF. Standard | Test Condition | Note | Number of Damaged |
|------------------------|--------------------------|------------------------|---|------------|-------------------|
| Environmental Sequence | Temperature Cycle | JIS C 7021 (1997) A-4 | -20°C→25°C→80°C→25°C 30mins,5mins,30mins,5mins | 100 cycles | 0/100 |
| | High Humidity Heat Cycle | JIS C 7021 (1997) A-5 | 30°C→65°C 90%RH 24hrs/1cycle | 10 cycles | 0/100 |
| | High Temperature Storage | JIS C 7021 (1997) B-10 | Ta=80°C | 1000hrs | 0/100 |
| | Humidity Heat Storage | JIS C 7021 (1997) B-11 | Ta=60°C RH=90% | 1000hrs | 0/100 |

● Test Items And Results

| | | | | | |
|----------------------|------------------------------|------------------------|---|----------------------|-------|
| | Low Temperature Storage | JIS C 7021 (1997) B-12 | Ta= -30°C | 1000hrs | 0/100 |
| Operation Sequence | Life Test | JIS C 7035 (1985) | Ta=25°C I _F =20mA | 1000hrs | 0/100 |
| | High Humidity Heat Life Test | * | 60°C RH=90% I _F =20mA | 500hrs | 0/100 |
| | Low Temperature Life test | * | Ta= -20°C I _F =20mA | 1000hrs | 0/100 |
| Destructive Sequence | Resistance to Soldering Heat | JIS C 7021 (1997) A-11 | Tsol=260 ± 5°C,10sec (3mm from the base of the epoxy bulb) | 1 time | 0/20 |
| | Solder ability | JIS C 7021 (1997) A-2 | Tsol=235 ± 5°C,5sec (Using flux) | 1 time (over 95%) | 0/20 |
| | Lead Pull/Bend Test | JIS C 7021 (1997)A-11 | Load 2.5N (0.25kgf) 0°→90°→0° Bending 3 times | No noticeable damage | 0/20 |

* Refer to reliability test standard specification for in this line.

● Criteria for Judging The Damage



乐清市裕林电子有限公司

Yueqing Yulin Electrical Co., Ltd

Address: F/6 No.19 Keaisi road xiangyang industrial zone road tantou liushi yueqing wenzhou

Tel: 0577-27878383

website: www.indicatorlight.com

Fax: 0577-27878383-8027

6. Resistor Specification (RMS 1/4W 200kΩ):

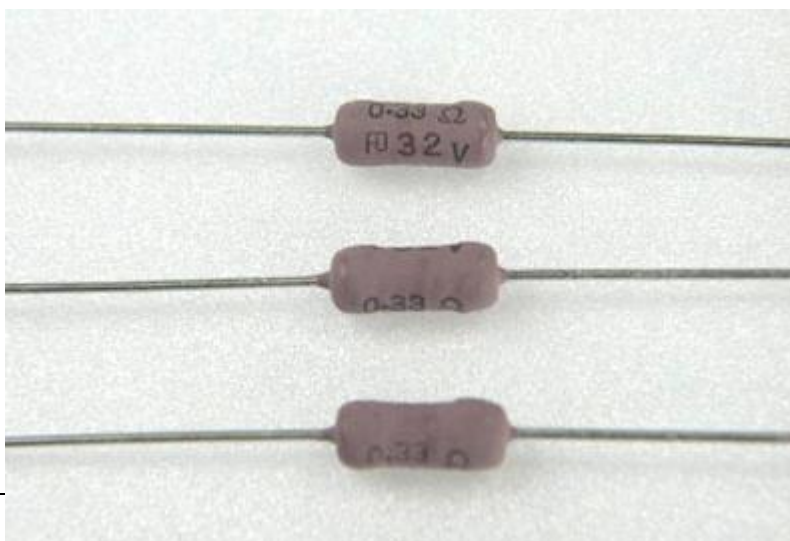

| Item | Symbol | Test Condition | Criteria for Judgment | |
|--------------------|----------------|-----------------------|-----------------------|--------------------|
| | | | Min. | Max. |
| Forward Voltage | V _F | I _F = 20mA | --- | Initial data x 1.1 |
| Reverse Current | I _R | V _R = 5V | --- | Initial data x 2.0 |
| Luminous Intensity | I _V | I _F = 20mA | Initial data x 0.7 | --- |

CHARACTERISTICS 性能

| ITEM 项目 | SPEC 规格 | REMARKS 备注 |
|--|--|---|
| Load life under high temperature 高温负荷寿命 | ±1.5% | JIS C 5201-1 (4.25.1) Rated voltage at 70°C for 1,000 hours 额定电压70°C 1,000 小时 |
| Load life under high humidity 耐湿负荷寿命 | ±5% | JIS C 5201-1 (4.24) Rated voltage at 40°C, 95% RH for 1,000 hours 额定电压40°C, 95% RH 1,000小时 |
| Temp. coeff of resistance 温度系数 | < 1K= ±500 PPM/°C ≅ 100KΩ=±300 ppm/°C >100KΩ=±200 ppm/°C | JIS C 5201-1 Room temp. + 100°C, 30min 室温 + 100°C, 30分钟 |
| Short time overload 短时间过负荷 | ±1% | JIS C 5201-1 (4.13) 6.25 times the rated power for 5 seconds 6.25倍额定功率 5 秒 |
| Temperature cycling 温度循环 | ±1% | JIS C 5201-1 (4.19) 5 cycles for -25°C±3°C(30min); room temp.(30min) ~ +85°C±3°C(30min) room temp. (30min) |
| Resistance to soldering heat 焊锡耐热 | ±1% | JIS C 5201-1 (4.18) 260°C±5°C for 10 seconds(焊锡槽) 350°C±10°C for 3.5 seconds(手焊锡) |
| Insulation resistance 绝缘电阻 | >1,000MΩ | JIS C 5201-1 (4.6.1.1) 500 volt Insulation test 1min 500 V绝缘测试电压1分钟 |



乐清市裕林电子有限公司

Yueqing Yulin Electrical Co., Ltd

Address: F/6 No.19 Keaisi road xiangyang industrial zone road tantou liushi yueqing wenzhou

Tel: 0577-27878383

website: www.indicatorlight.com

Fax: 0577-27878383-8027

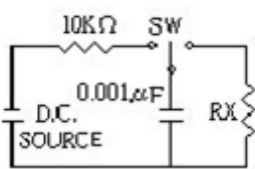
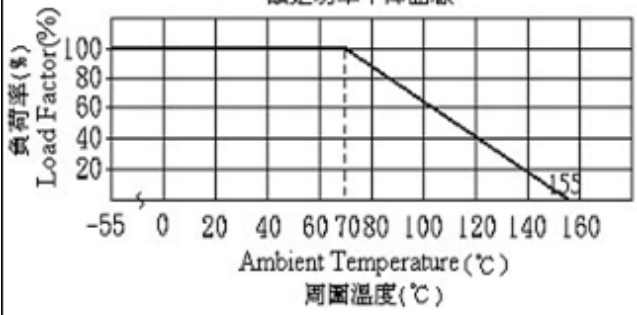
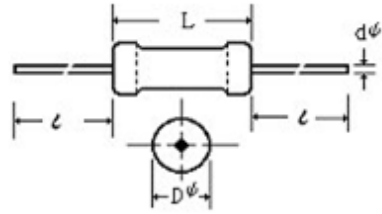
| | | |
|--|---|--|
| Pulse withstanding voltage 脉冲 | $\pm 20\%$ | <p> ■The following discharge cycle is repeated in the circuit of the left fig. 2.5 sec. ON 2.5 sec. OFF 50 cycles. With following DC pulse test voltage ■ Pulse voltage:1/6W,S1/4W: 3KV. $\geq 1/4W$: 100KΩ: (3KV); 100KΩ-620KΩ: (5KV); > 620KΩ: (10KV) </p>  |
| <p>DERATING CURVE 額定功率下降曲線</p>  |  | <p> Various type of forming & taping are available 提供插装的造型与带装 Coating color: RMU1/4W,RMU1/6W \ dark blue, other \ pink. 涂装颜色: RMU1/4W,RMU1/6W蓝色,其他粉红色。 </p> |

■ CHARACTERISTICS 性能

| Model 型名 | Power Rating 额定功率 (W) | Resistance Range E-24 阻值范围 Ω | Maximum Working Voltage 最高使用 电压 | Dielectric Withstandi ng Voltage 耐电压 | Dimension 尺寸 (mm) | | | |
|-------------------------|--------------------------------|--|---|--|-------------------|---------------|------------|----------------|
| | | | | | L | D ϕ | t | d ϕ |
| RMU1/4W 、 RMS1/2W | 1/4,1/2 | 10 Ω ~ <100M | 1600V | 700V | 6 \pm 0.3 | 2.4 \pm 0.1 | 28 \pm 2 | 0.6 \pm 0.05 |